

Let's get started

1 Connect to your TV.

Make all connections before plugging the AC power cord into an electrical outlet. Use the supplied HDMI cable for the connection.

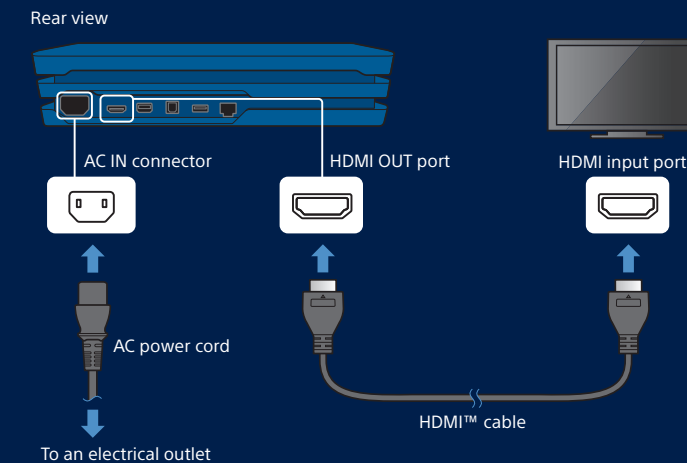

2 Connect to the Internet.

We recommend use of a LAN cable (sold separately) for a more stable network connection. If you prefer to use a wireless connection (Wi-Fi), don't connect a LAN cable.

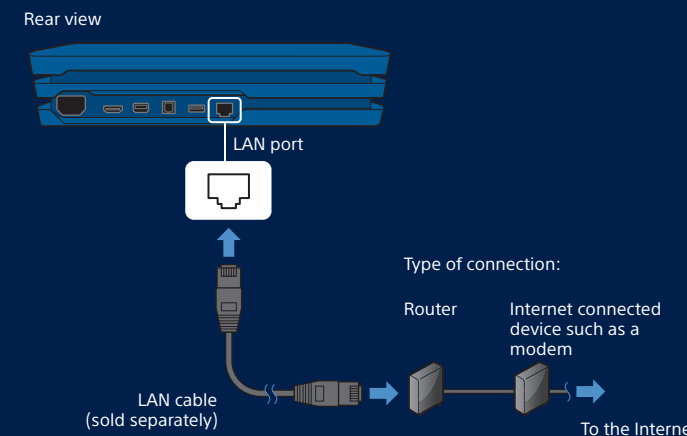

3 Turn on your TV and set the input to HDMI.

4 Turn on your PS4™ system by pressing the (power) button.

The power indicator blinks blue, and then turns white.

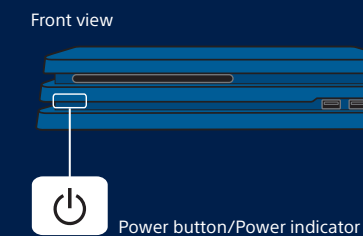

5 Connect your DUALSHOCK®4 wireless controller to your system using the USB cable, and then press the (PS) button.

Your controller pairs with your system and turns on.

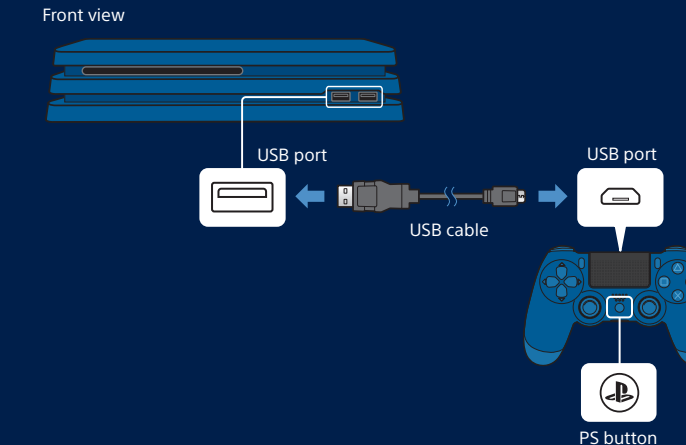

6 Make it your own.

You're almost done! Follow the on-screen instructions to set up an Internet connection, set the date and time, and configure other settings - then select [Start Now] from the setup screen. After you set up your Internet connection, a system software update may automatically download. Future updates will improve performance and add new features.

Will a child be using your PS4™ system? If so, be sure to read the "Parental controls" section.

To later change any settings that you skipped, select (Settings) from the function screen.

Parental controls

If children will be using the PS4™ system, parents or guardians can restrict access to certain content or features and set limits for when and how long children can play. For details on what can be restricted and how to set restrictions, refer to the User's Guide. manuals.playstation.net/en/01.html



You can restrict the use of games that have age limitations by setting the parental control level according to the following table.

Singapore

Parental control level	7	9
Approximate age of user	16	18
Game rating labels	Suitable For 16 & Above	M18

- For details on your PlayStation®Camera or attaching the vertical stand, refer to the Safety Guide.
- You can transfer saved data from your current PlayStation®4 system to your new PS4™ system. We recommend that you transfer data before using your new system for the first time. For details on how to transfer data and what type of data you can transfer, refer to the User's Guide. manuals.playstation.net/en/04.html



Get the most out of your PS4™ system by connecting to the Internet. You'll be able to play games online and connect with Friends.¹

If your TV does not display a picture when the power indicator turns white, restart your system. Press the (power) button for at least 7 seconds to turn off your system, and then turn it on again.

- You'll need to pair a controller when you use it for the first time and when you use your controller on another PS4™ system. If you want to use two or more controllers, you must pair each controller.
- After you've paired your controller, you can disconnect the USB cable and use your controller wirelessly.
- It's possible to use up to four controllers at the same time. When you press the (PS) button, the light bar glows in your assigned color. The first controller to connect is blue, with subsequent controllers glowing red, green, and pink.

To later change any settings that you skipped, select (Settings) from the function screen.



Quick Start Guide

English

CUH-7106B



© 2018 Sony Interactive Entertainment Inc. Printed in China



4-739-816-61(1)

Take a look around

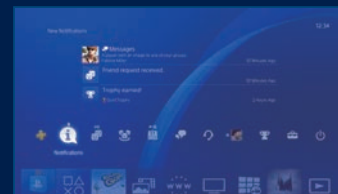

Function screen

Access PS4™ system features, including notifications, your Friends, and settings.

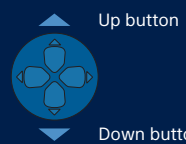

Up button

Down button

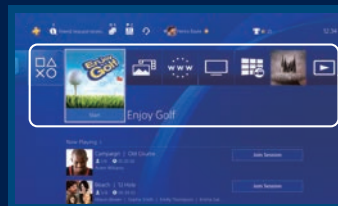

Home screen

Content area
Access your games and other content.

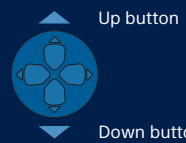

Up button

Down button



Content info screen

The latest information about the selected content is displayed.

Let's play

Start the game

Insert a disc. Select the game from the content area to start playing. No game disc? Check out PlayStation™Store for downloadable games. See "Sign in to PlayStation™Network".

Front view



Return to the home screen from a game

To return to the home screen without ending a game, press the (PS) button. To resume playing the game, select it from the content area.

End the game

Press and hold the (PS) button, and then select [Close Application] from the quick menu that appears.

Eject the disc

Press the (eject) button.

Front view

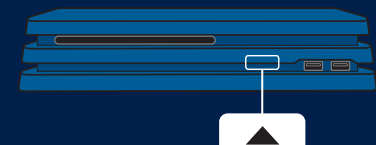

Eject button

Connect the mono headset

For in-game voice chat, plug the mono headset into your controller's stereo headset jack.

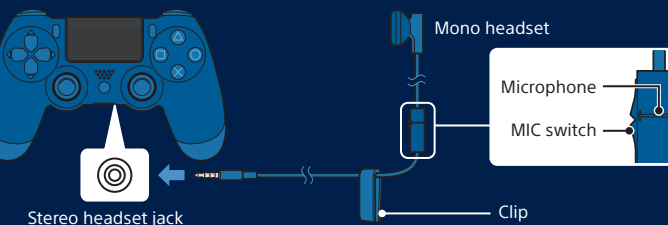

Charge your controller

With your PS4™ system either on or in rest mode, connect your controller using a USB cable. For details on rest mode, read the "Shutting down" section.

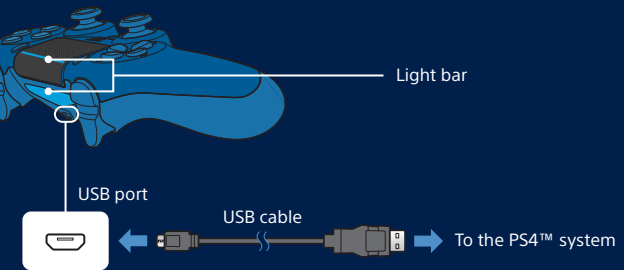

To charge your controller while your system is in rest mode, select an option other than [Off] in (Settings) > [Power Save Settings] > [Set Features Available in Rest Mode] > [Supply Power to USB Ports].

Sign in to PlayStation™Network

PlayStation™Network is an online service that lets you expand your enjoyment of your PS4™ system. Sign in to download games from PlayStation™Store, share your gameplay, and use a variety of other features and services.

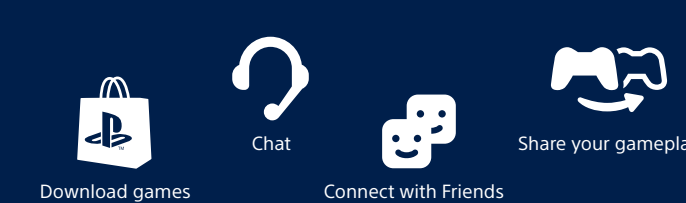

To sign in to PlayStation™Network, you must have a Sony Entertainment Network account. For details on signing in, refer to the User's Guide. manuals.playstation.net/en/03.html



Share your gaming experience

Share your gameplay online

Press the SHARE button and choose one of these options for sharing your gameplay online.



Upload a screenshot

Capture a screenshot of your gameplay and upload it to your social networks, or use (Messages) to send it to Friends.



Broadcast your gameplay live

Broadcast your gameplay to a live streaming service so others can watch your adventures.

View shared gameplay

Use (Live from PlayStation) to view broadcasts, video clips, or screenshots shared by other players.



Play a game together

Use (Share Play) to share the game screen with another player and play the same game together.*2



For details on the share feature, refer to the User's Guide. manuals.playstation.net/en/02.html



Shutting down

Caution

Disconnect the AC power cord from the electrical outlet only when the power indicator is off. If you disconnect it while the power indicator is lit or blinking, data might be lost or become corrupted, and you might damage your system. Be sure to read the "Turn off your system completely" section below.

Put your system in rest mode

You can keep your PS4™ system in rest mode when you're not using it. When your system is in rest mode, it keeps operating, but at a lower power consumption. You can configure your system to download files and charge a controller while it's in rest mode.

Select (Power) from the function screen, and then select [Enter Rest Mode]. The power indicator blinks white, and then turns orange. To exit rest mode, press the (PS) button.

Turn off your system completely

Select (Power) from the function screen, and then select [Power Options] > [Turn Off PS4]. The power indicator blinks white, and then turns off.

Power indicator

White	System is on.
Orange	System is in rest mode.
Off	System is off.

Further information

User's Guide

Find out about everything your PS4™ system can do. Learn how to configure settings and how to use each function. Select (Settings) > (User's Guide/Helpful Info) > (User's Guide) from the function screen.

You can also view the User's Guide by visiting: manuals.playstation.net/document/en/ps4/



Safety Guide

Learn how to use your PS4™ system safely. This manual also contains information about specifications. Be sure to read it before using your system.

*1 Online multi-play requires PlayStation®Plus membership.

*2 Share Play may require PlayStation®Plus membership. Not all games support this feature. For details on PlayStation®Plus, refer to the User's Guide. manuals.playstation.net/en/05.html



"PS", "PlayStation", "PS4" and "DUALSHOCK" are registered trademarks or trademarks of Sony Interactive Entertainment Inc.

"SONY", "PS" and "Sony Entertainment Network" are registered trademarks or trademarks of Sony Corporation.

The terms HDMI and HDMI High-Definition Multimedia Interface, and the HDMI Logo are trademarks or registered trademarks of HDMI Licensing Administrator, Inc. in the United States and other countries.

Design and specifications are subject to change without notice. Information about system functionality and images published in this document may vary from those for your system, depending on the system software version in use. Also, the illustrations and screen images used in this guide may vary from the actual product.